



STMPS2141, STMPS2151 STMPS2161, STMPS2171

Enhanced single channel power switches

Features

- 90 mΩ high-side MOSFET switch
- 500/1000 mA continuous current
- Thermal and short-circuit protection with overcurrent logic output
- Operating range from 2.7 V to 5.5 V
- CMOS- and TTL-compatible enable inputs
- Undervoltage lockout (UVLO)
- 12 μA maximum standby supply current
- Ambient temperature range, -40°C to 85°C
- 8 kV ESD protection
- Reverse current protection
- Fault-blanking

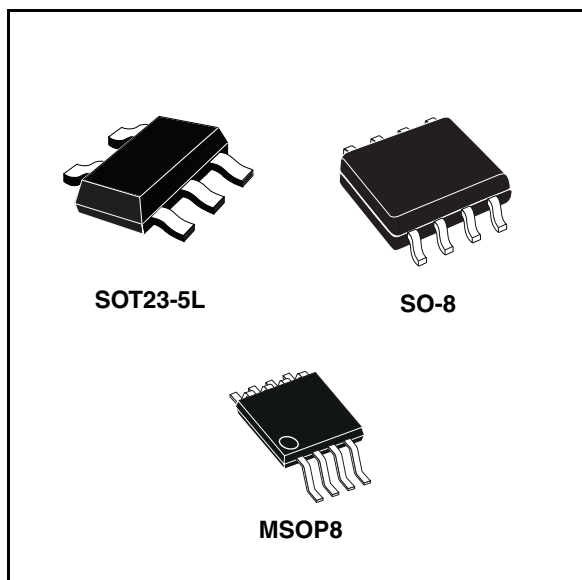

Description

The STMPS2141, STMPS2151, STMPS2161, STMPS2171 power distribution switches are intended for applications where heavy capacitive loads and short circuits are likely to be encountered. These devices incorporate 90 mΩ N-channel MOSFET high-side power switches for power-distribution. These switches are controlled by a logic enable input.

When the output load exceeds the current-limit threshold or a short is present, the device limits the output current to a safe level by switching into a constant-current mode. When continuous heavy overloads and short circuits increase the power dissipation in the switch, causing the junction temperature to rise, a thermal protection circuit shuts the switch off to prevent damage. Recovery from a thermal shutdown is automatic once the device has cooled sufficiently. Internal circuitry ensures the switch remains off until a valid input voltage is present.

Table 1. Device summary

Order codes			Current limit (mA)	Enable
SO-8	SOT23-5L	MSOP8 ⁽¹⁾		
STMPS2141MTR	STMPS2141STR	STMPS2141TTR	500	Active low
STMPS2151MTR	STMPS2151STR	STMPS2151TTR	500	Active high
STMPS2161MTR	STMPS2161STR	STMPS2161TTR	1000	Active low
STMPS2171MTR	STMPS2171STR	STMPS2171TTR	1000	Active high

1. MSOP8 package is also known as "TSSOP8"

Contents

- 1 Block diagram 3**
- 2 Pin settings 4**
 - 2.1 Pin connections 4
 - 2.2 Pin description 4
- 3 Functional description 5**
 - 3.1 Fault blanking 5
 - 3.2 Overcurrent/over-temperature protection 5
 - 3.3 FAULT conditions 5
 - 3.4 Reversed current blocking 6
 - 3.5 UVLO 6
- 4 Ambient temperature 7**
- 5 Maximum rating 8**
 - 5.1 Absolute maximum rating 8
 - 5.2 Recommended operating conditions 8
- 6 Electrical specification 9**
- 7 Detail device characteristics 12**
 - 7.1 Additional electrical charts 12
 - STMPS2141, STMPS2151 12
 - V_{OUT} = 5.0 V 12
 - STMPS2161, STMPS2171 17
 - V_{OUT} = 5.0 V 17
- 8 Package mechanical data 22**
- 9 Revision history 26**

List of figures

Figure 1. Block diagram 5

Figure 2. SOT23-5L, SO-8 and MSOP8 pin connections 6

Figure 3. Voltage output turn on delay time 14

Figure 4. Voltage output turn off delay time 14

Figure 5. Current output turn on delay time 14

Figure 6. Current output turn off delay time 14

Figure 7. Voltage output turn on delay time 14

Figure 8. Voltage output turn off delay time 14

Figure 9. Current output turn on delay time 15

Figure 10. Current output turn off delay time 15

Figure 11. UVLO rising 15

Figure 12. UVLO falling 15

Figure 13. OC protection at $V_{OUT} = 3.0\text{ V}$ 16

Figure 14. OC protection at $V_{OUT} = 3.0\text{ V}$ 16

Figure 15. OC protection at $V_{OUT} = 5.0\text{ V}$ 16

Figure 16. OC protection at $V_{OUT} = 5.0\text{ V}$ 16

Figure 17. I_{CC} vs V_{IN} (enabled) 16

Figure 18. I_{CC} vs temperature (enabled) 16

Figure 19. I_{CC} vs V_{IN} (disabled) 17

Figure 20. I_{CC} vs temperature (disabled) 17

Figure 21. RDS ON vs V_{IN} 17

Figure 22. RDS ON vs temperature 17

Figure 23. ILIMIT vs temperature 17

Figure 24. Switch leakage vs temperature 17

Figure 25. Output rise time vs. V_{IN} 18

Figure 26. Output fall time vs. V_{IN} 18

Figure 27. UVLO vs temperature 18

Figure 28. Voltage output turn on delay time 19

Figure 29. Voltage output turn off delay time 19

Figure 30. Current output turn on delay time 19

Figure 31. Current output turn off delay time 19

Figure 32. Voltage output turn on delay time 20

Figure 33. Voltage output turn off delay time 20

Figure 34. Current output turn on delay time 20

Figure 35. Current output turn off delay time 20

Figure 36. UVLO rising 20

Figure 37. UVLO falling 20

Figure 38. OC protection at $V_{OUT} = 3.0\text{ V}$ 21

Figure 39. OC protection at $V_{OUT} = 3.0\text{ V}$ 21

Figure 40. OC protection at $V_{OUT} = 5.0\text{ V}$ 21

Figure 41. OC protection at $V_{OUT} = 5.0\text{ V}$ 21

Figure 42. I_{CC} vs V_{IN} (enabled) 22

Figure 43. I_{CC} vs temperature (enabled) 22

Figure 44. I_{CC} vs V_{IN} (disabled) 22

Figure 45. I_{CC} vs temperature (disabled) 22

Figure 46. RDS ON vs V_{IN} 22

Figure 47. RDS ON vs temperature 22

Figure 48. ILIMIT vs temperature 23

Figure 49.	Switch leakage vs temperature	23
Figure 50.	Output rise time vs. VIN	23
Figure 51.	Output fall time vs. VIN	23
Figure 52.	UVLO vs temperature	23
Figure 53.	SOT23-5L package outline	24
Figure 54.	SOT23-5L footprint recommendation	25
Figure 55.	SO-8 package outline	26
Figure 56.	MSOP8 package outline	27

List of tables

Table 1.	Device summary	1
Table 2.	Pin description	7
Table 3.	FAULT conditions	8
Table 4.	SOT23-5L (160 °C/W)	10
Table 5.	MSOP8 (220 °C/W)	10
Table 6.	SO-8 (160 °C/W)	10
Table 7.	Absolute maximum ratings	11
Table 8.	Recommended operating conditions	11
Table 9.	SOT-23-5L electrical characteristics	12
Table 10.	MSO8/SO8 electrical characteristics	12
Table 11.	Current limit characteristics ($V_I = 5.5\text{ V}$, $I_O = \text{rated current}$, $T_J = 25\text{ °C}$, unless otherwise specified)	13
Table 12.	Supply current characteristics ($V_I = 5.5\text{ V}$, $I_O = \text{rated current}$, $T_J = 25\text{ °C}$, unless otherwise specified)	13
Table 13.	Thermal characteristics ($V_I = 5.5\text{ V}$, $I_O = \text{rated current}$, $T_J = 25\text{ °C}$, unless otherwise specified)	14
Table 14.	UVLO characteristics ($V_I = 5.5\text{ V}$, $I_O = \text{rated current}$, $T_J = 25\text{ °C}$, unless otherwise specified)	14
Table 15.	OC pin characteristics ($V_I = 5.5\text{ V}$, $I_O = \text{rated current}$, $T_J = 25\text{ °C}$, unless otherwise specified)	14
Table 16.	EN pin characteristics ($V_I = 5.5\text{ V}$, $I_O = \text{rated current}$, $T_J = 25\text{ °C}$, unless otherwise specified)	14
Table 17.	SOT23-5L mechanical data	25
Table 18.	SOT23-5L footprint dimensions	26
Table 19.	SO-8 mechanical data	27
Table 20.	MSOP8 package mechanical data	28
Table 21.	Document revision history	29

1 Block diagram

Figure 1. Block diagram

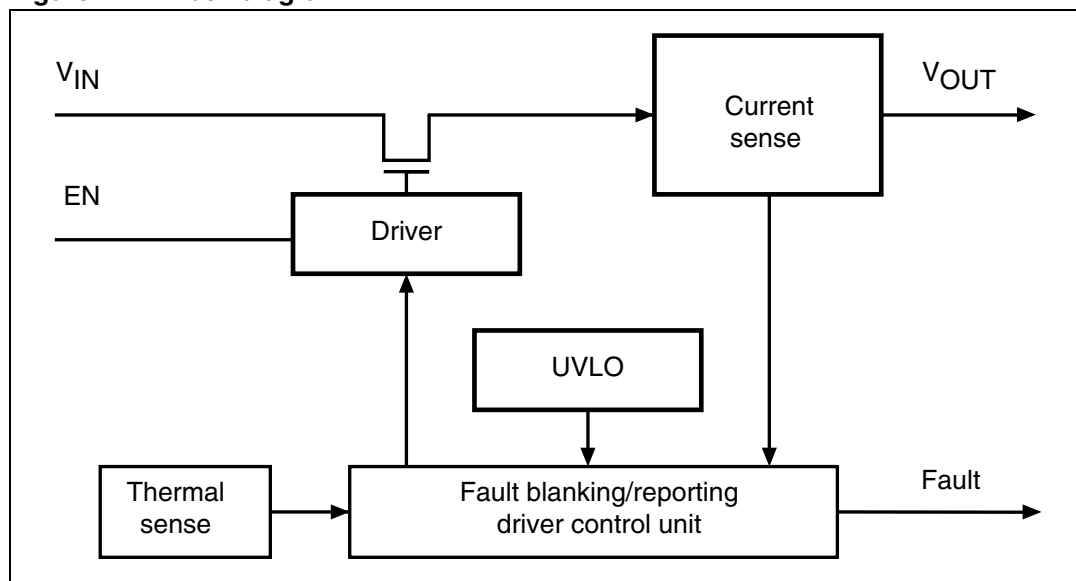

2 Pin settings

2.1 Pin connections

Figure 2. SOT23-5L, SO-8 and MSOP8 pin connections

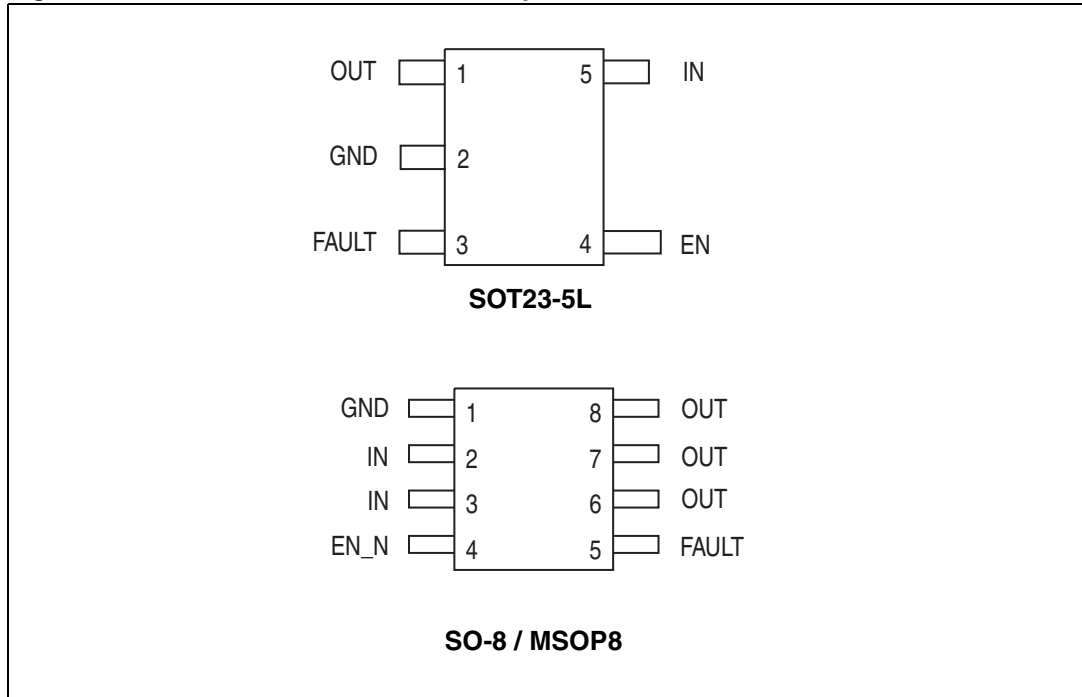

2.2 Pin description

Table 2. Pin description

Pin number			Name	Function
SO8	MSOP8	SOT23-5L		
1	1	2	GND	Ground
2	2	5	IN	2.7 V - 5.5 V input
3	3	-	IN	2.7 V - 5.5 V input
4	4	4	EN	Enable for power switch
5	5	3	FAULT	Open drain FAULT indicator, active low
6	6	1	OUT	Output of power switch
7	7	-	OUT	Output of power switch
8	8	-	OUT	Output of power switch

3 Functional description

3.1 Fault blanking

The STMPS devices feature a 10 ms fault blanking. Fault blanking allows current-limit faults, including momentary short-circuit faults that occur when hot-swapping a capacitive load, and also ensures that no fault is issued during power-up. When a load transient causes the device to enter current limit, an internal counter starts. If the load fault persists beyond the 10 ms fault-blanking timeout, the FAULT output asserts “low”. Load-transient faults less than 10 ms (typ.) do not cause a FAULT output assertion. Only current-limit faults are blanked. Die over-temperature faults and input voltage drops below the UVLO threshold cause an immediate fault output.

3.2 Overcurrent/over-temperature protection

In overcurrent or short-circuit condition, the switch limits the current at a value of about 120% of the rated current. If the temperature of the die goes above the limit value, the switch turns off.

3.3 FAULT conditions

In applications of power switch, 3 types of FAULT conditions are common. These fault conditions and the response of STMPS21x1 power switches are described in the following table.

Table 3. FAULT conditions

Fault	Condition	STMPS21x1 action
Short circuit	Output shorted to GND via resistance path of $< 1 \Omega$ causing a rapid current surge	Turn off output until short is removed, assert FAULT pin
Over-current	Output connected to a load that sinks current above threshold	Reduces output voltage to reduce the current. Assert FAULT pin after a blanking period
Overheating	Temperature of junction exceeds 135°C due to any reason	Turn OFF output until temperature falls below 125°C . Asserts FAULT pin immediately

3.4 Reversed current blocking

When the switch is OFF, or when the STMPS device is un-powered ($V_{CC} = 0V$), the switch behaves as an Hi-Z at the output pin, ensuring that no reverse current will flow into the device.

Note: In the case where the switch is ON, and a voltage higher than V_{IN} is applied to the OUT pin, a reverse current occurs. This operating condition is not allowed.

3.5 UVLO

When input voltage drops below critical value, the power switch turns off to prevent improper operation due to low voltage.

4 Ambient temperature

In Enable operating mode, an amount of power is dissipated as heat in the power switch due to the on-resistance. The power dissipation is: $P = I^2R$

Table 4. SOT23-5L (160 °C/W)

Part number	Max current	Max R_{ON} at 5 V	Power dissipation	Temperature difference (Junction and Ambient)	Maximum ambient temperature (at Junction temperature 125 °C)
STMPS2141	0.50 A	130 mΩ	32.5 mW	6.2	118.8
STMPS2151					
STMPS2161	1.00 A	130 mΩ	130.0 mW	24.8	100.2
STMPS2171					

Table 5. MSOP8 (220 °C/W)

Part number	Max current	Max R_{ON} at 5 V	Power dissipation	Temperature difference (Junction and Ambient)	Maximum ambient temperature (at Junction temperature 125 °C)
STMPS2141	0.50 A	130 mΩ	32.5 mW	7.2	117.8
STMPS2151					
STMPS2161	1.00 A	130 mΩ	130.0 mW	28.6	96.4
STMPS2171					

Table 6. SO-8 (160 °C/W)

Part number	Max current	Max R_{ON} at 5V	Power dissipation	Temperature difference (Junction and Ambient)	Maximum ambient temperature (at Junction temperature 125 °C)
STMPS2141	0.50 A	130 mΩ	32.5 mΩ	5.2	124.8
STMPS2151					
STMPS2161	1.00 A	130 mΩ	130.0 mΩ	20.8	104.2
STMPS2171					

5 Maximum rating

Stressing the device above the rating listed in the “Absolute Maximum Ratings” table may cause permanent damage to the device. These are stress ratings only and operation of the device at these or any other conditions above those indicated in the Operating sections of this specification is not implied. Exposure to Absolute Maximum Rating conditions for extended periods may affect device reliability. Refer also to the STMicroelectronics SURE Program and other relevant quality documents.

5.1 Absolute maximum rating

Table 7. Absolute maximum ratings

Symbol	Parameter	Value	Unit
V _I	Input voltage range	-0.3 – 6.0	V
V _O	Output voltage range	-0.3 – (V _I +0.3)	V
V _{IENX}	EN Input voltage range	-0.3 – 6.0	V
I _O	Continuous output current	Internally limited	
ESD	ESD protection level	8	kV
T _J	Junction operating temperature	-40 to 125	°C
T _{STG}	Storage temperature	-55 to 150	°C
T _R	Thermal resistance (MSOP8)	220	°C/W
T _R	Thermal resistance (SOT23-5L)	191	°C/W
T _R	Thermal resistance (SO-8)	160	°C/W

5.2 Recommended operating conditions

Table 8. Recommended operating conditions

Symbol	Parameter	Value			Unit
		Min	Typ	Max	
V _I	Input voltage	2.7	5.0	5.5	V
V _O	Output voltage	0	5.0	5.5	V
I _O (STMP2141 STMP2151)	Continuous output current	0	-	500	mA
I _O (STMP2161 STMP2171)	Continuous output current	0	-	1000	mA

6 Electrical specification

Table 9. SOT-23-5L electrical characteristics

Symbol	Parameter	Test condition	Value			Unit
			Min	Typ	Max	
Rds on	Static drain source ON state resistance SOT23-5L package load = 500 mA (STMPS2141/ STMPS2151) load = 1000 mA (STMPS2161/ STMPS2171)	VI = 2.7 V ; TJ = 25°C;		120	160	mΩ
		VI = 5.0 V ; TJ = 25°C;		90	110	mΩ
Rds on	Static drain source ON state resistance	VI = 2.7 V ; - 40 < TJ < 125°C			200	mΩ
		VI = 5.0 V ; - 40 < TJ < 125°C			135	
Tr	Output rise time	VI = 5.0 V RL = 10 Ω CL = 1 μF	0.05		2	mS

Table 10. MSO8P/SO8 electrical characteristics

Symbol	Parameter	Test condition	Value			Unit
			Min	Typ	Max	
Rds on	Static drain source ON state resistance SO-8 and MSO8 package load = 500 mA (STMPS2141/ STMPS2151) load = 1000 mA (STMPS2161/ STMPS2171)	VI = 2.7 V ; TJ = 25°C;		130	170	mΩ
		VI = 5.0 V ; TJ = 25°C;		110	125	mΩ
Rds on	Static drain source ON state resistance	VI = 2.7 V ; - 40 < TJ < 125°C			200	mΩ
		VI = 5.0 V ; - 40 < TJ < 125°C			140	
Tr	Output rise time	VI = 5.0 V RL = 10 Ω CL = 1 μF	0.05		2	mS

Table 11. Current limit characteristics
 ($V_I = 5.5\text{ V}$, $I_O = \text{rated current}$, $T_J = 25^\circ\text{C}$, unless otherwise specified)

Symbol	Parameter	Test condition	Value			Unit
			Min	Typ	Max	
I_{OS} (STMP2141 STMP2151)	Overcurrent limiting threshold	$V_I = 5\text{ V}$ $V_{OUT} = 4.5\text{ V}$	0.60	0.80	1.00	A
I_{OS} (STMP2161 STMP2171)	Overcurrent limiting threshold		1.10	1.50	1.90	A
I_{OS} (2141,2151)	Short circuit output current	$V_I = 5\text{ V}$, OUT connected to GND, device enabled into short circuit			0.9	A
I_{OS} (2161,2171)	Short circuit output current				1.8	A

Table 12. Supply current characteristics
 ($V_I = 5.5\text{ V}$, $I_O = \text{rated current}$, $T_J = 25^\circ\text{C}$, unless otherwise specified)

Symbol	Parameter	Test condition	Value			Unit
			Min	Typ	Max	
I_{off}	Switch turned off	No load		6.0	12	μA
		No load; $-40 < T_J < 125^\circ\text{C}$			15	
I_{on}	Switch turned on	No load		40	60	μA
		No load; $-40 < T_J < 125^\circ\text{C}$			70	
$I_{leakage}$	Output leakage current ⁽¹⁾	Output grounded, switch is OFF			2	μA
		Output grounded, switch is OFF; $-40 < T_J < 125^\circ\text{C}$			5	
$I_{reverse}$	Reversed leakage current	Input grounded, Output connected to 5.5 V, 25°C		0.5	2	μA
		Input grounded, Output connected to 5.5 V, 125°C		0.5	3	

1. $I_{leakage} = I_{off-ground} - I_{off}$, where $I_{off-ground}$ = current into V_{in} when switch is off and output is grounded

Table 13. Thermal characteristics $(V_I = 5.5 \text{ V}, I_O = \text{rated current}, T_J = 25^\circ\text{C}, \text{ unless otherwise specified})$

Symbol	Parameter	Test condition	Value			Unit
			Min	Typ	Max	
T1	Thermal shutdown threshold				145	°C
T2	Recovery from thermal shutdown		120			°C
Hysteresis				14		°C

Table 14. UVLO characteristics $(V_I = 5.5 \text{ V}, I_O = \text{rated current}, T_J = 25^\circ\text{C}, \text{ unless otherwise specified})$

Symbol	Parameter	Test condition	Value			Unit
			Min	Typ	Max	
V _{UVLO}	Undervoltage lockout threshold		2.0		2.5	V
Hysteresis			40	75	110	mV

Table 15. OC pin characteristics $(V_I = 5.5 \text{ V}, I_O = \text{rated current}, T_J = 25^\circ\text{C}, \text{ unless otherwise specified})$

Symbol	Parameter	Test condition	Value			Unit
			Min	Typ	Max	
OC Blanking	OCx assertion and de-assertion		4	8	15	ms
V _O	Output low voltage	I _O = 5 mA			0.4	V
I _{OFF}	Off current	V _{OC} = 2.7 V, 5.5 V (No OC Condition)			1.0	μA

Table 16. EN pin characteristics $(V_I = 5.5 \text{ V}, I_O = \text{rated current}, T_J = 25^\circ\text{C}, \text{ unless otherwise specified})$

Symbol	Parameter	Test condition	Value			Unit
			Min	Typ	Max	
V _{IH}	High level input voltage	V _I = 2.7 V to 5.5 V	2.0			V
V _{IL}	Low level input voltage	V _I = 4.5 V to 5.5 V			0.8	V
		V _I = 2.7 V to 4.5 V			0.4	V
I _I	Input current	V _{IENX} = 0 V or V _I	-0.5		0.5	μA
t _{ON}	Turn-ON time ⁽¹⁾	R _L = 10 Ω C _L = 100 mF			5	ms
t _{OFF}	Turn-OFF time ⁽¹⁾	R _L = 10 Ω C _L = 100 mF			10	ms

1. Not tested in production, specified by design

7 Detail device characteristics

7.1 STMP2141, STMP2151 additional electrical charts

7.1.1 Turn on/off characteristics at $V_{OUT} = 5.0\text{ V}$

Figure 3. Voltage output turn on delay time

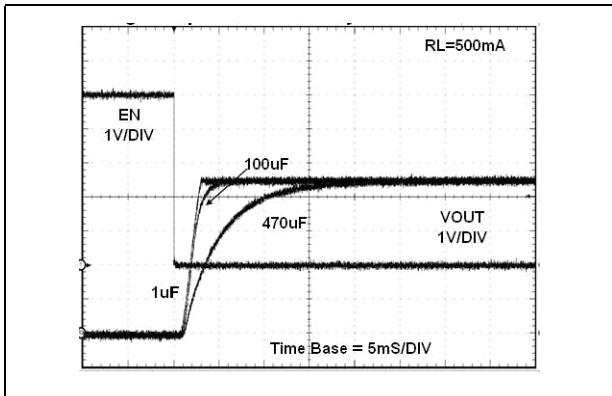

Figure 4. Voltage output turn off delay time

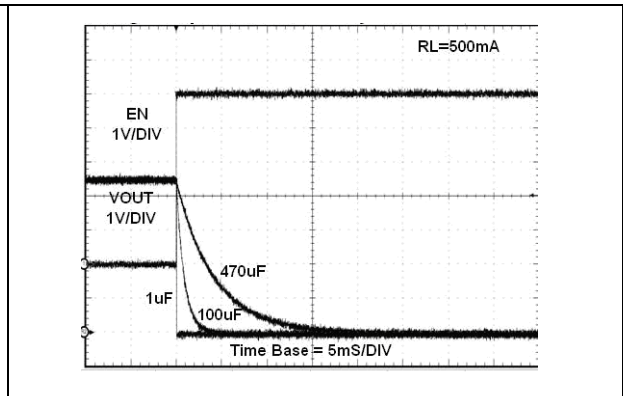

Figure 5. Current output turn on delay time

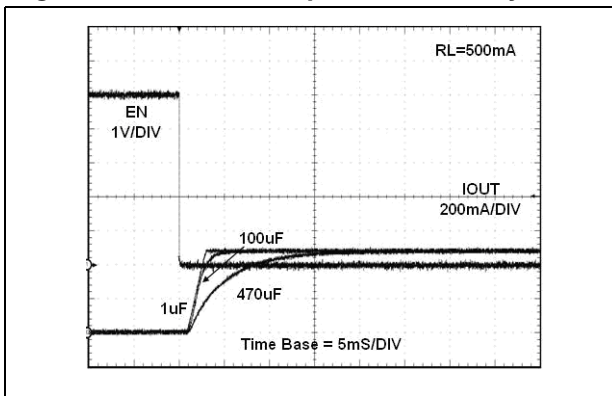
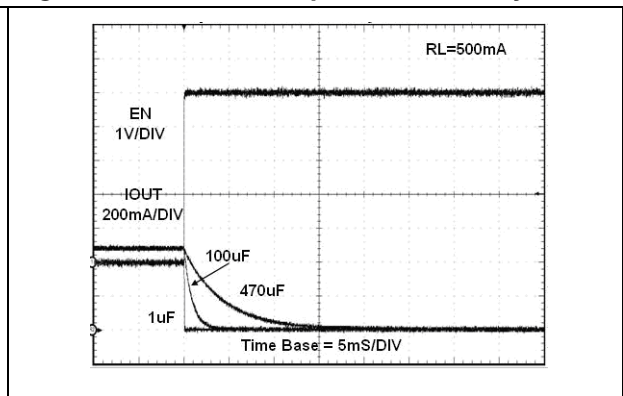

Figure 6. Current output turn off delay time



7.1.2 Turn on/off characteristics at $V_{OUT} = 3.0\text{ V}$

Figure 7. Voltage output turn on delay time

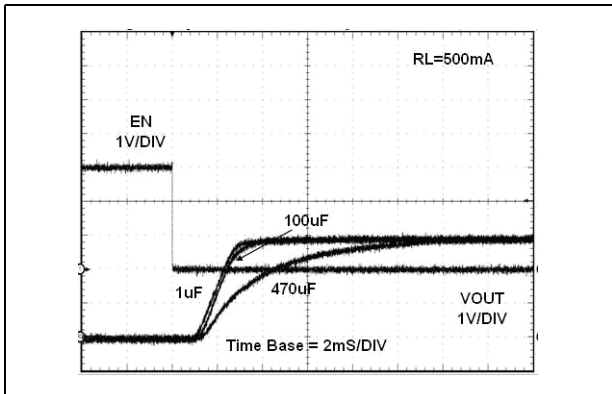

Figure 8. Voltage output turn off delay time

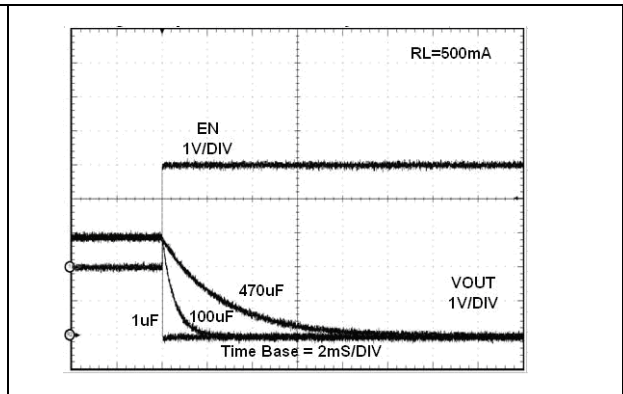

Figure 9. Current output turn on delay time

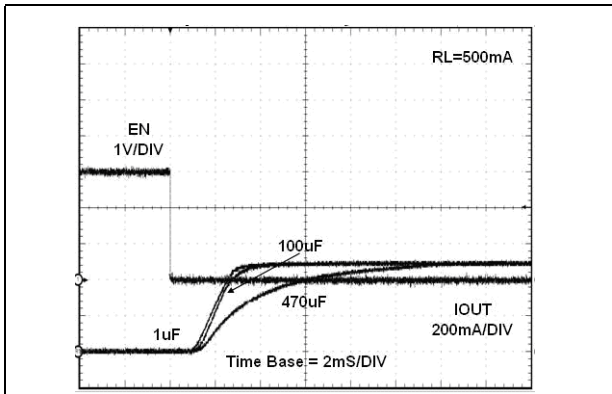
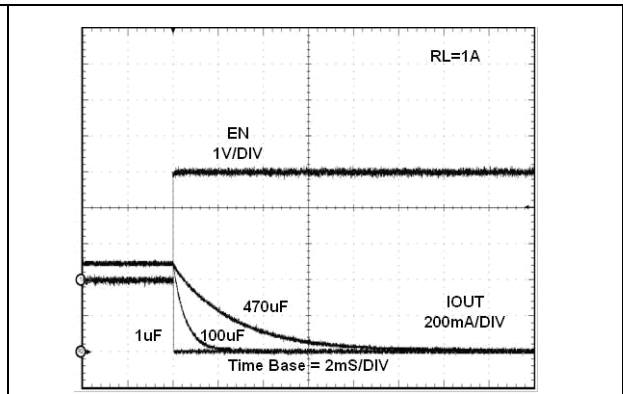

Figure 10. Current output turn off delay time



7.1.3 UVLO

Figure 11. UVLO rising

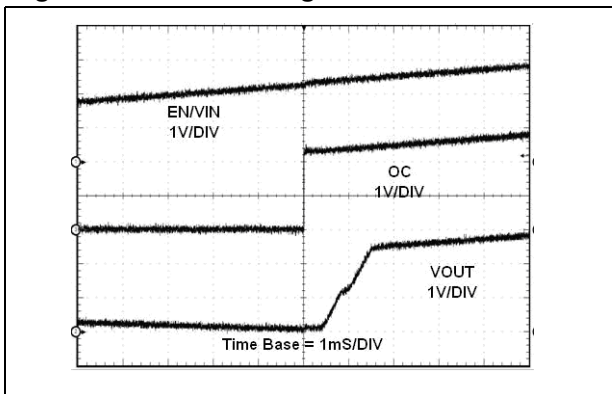
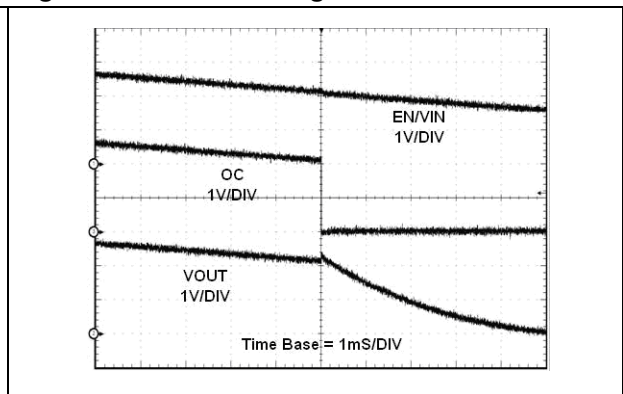

Figure 12. UVLO falling



7.1.4 OC protection characteristics

Figure 13. OC protection at $V_{OUT} = 3.0\text{ V}$

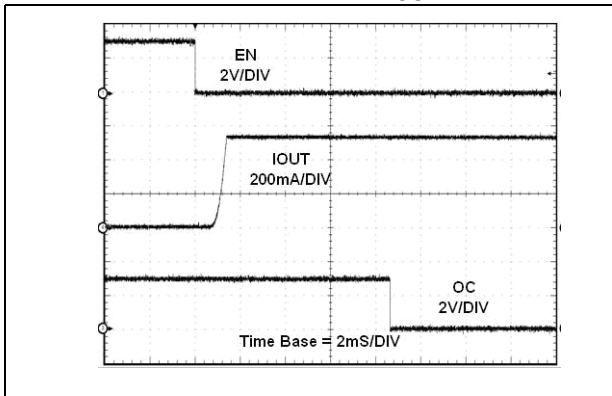

Figure 14. OC protection at $V_{OUT} = 3.0\text{ V}$

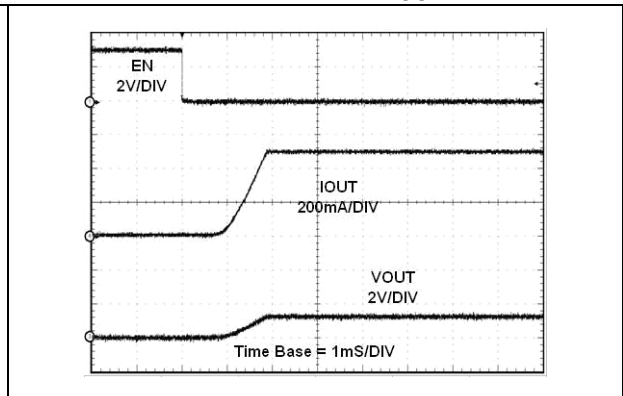

Figure 15. OC protection at $V_{OUT} = 5.0\text{ V}$

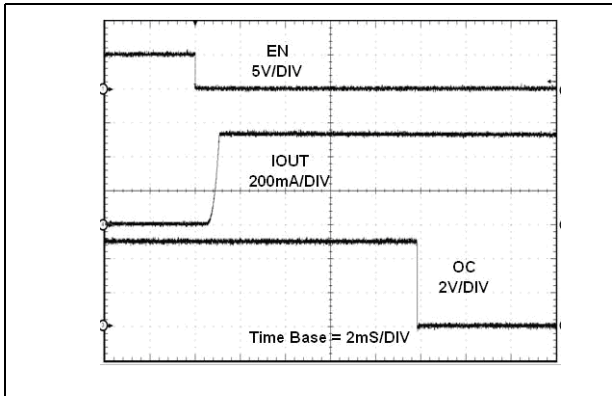
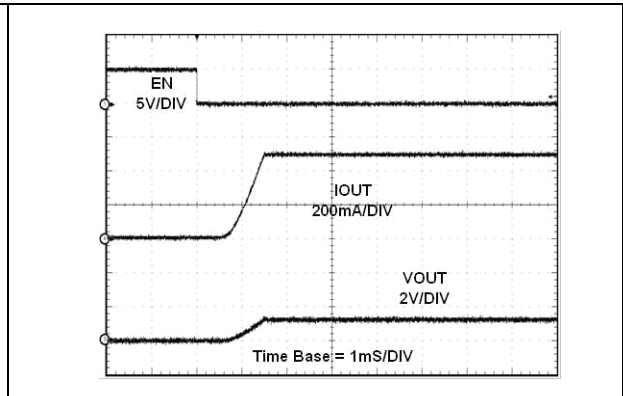

Figure 16. OC protection at $V_{OUT} = 5.0\text{ V}$



7.1.5 Other electrical characteristics

Figure 17. I_{CC} vs V_{IN} (enabled)

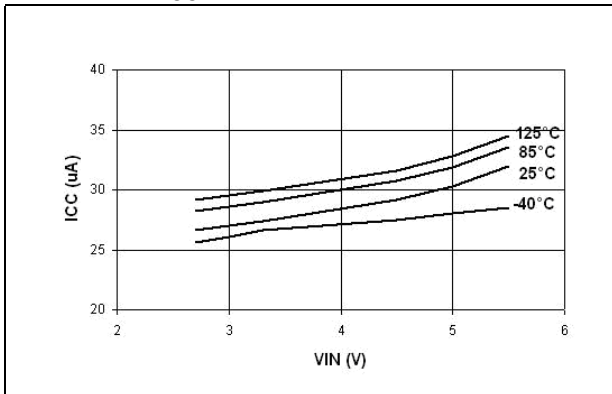

Figure 18. I_{CC} vs temperature (enabled)

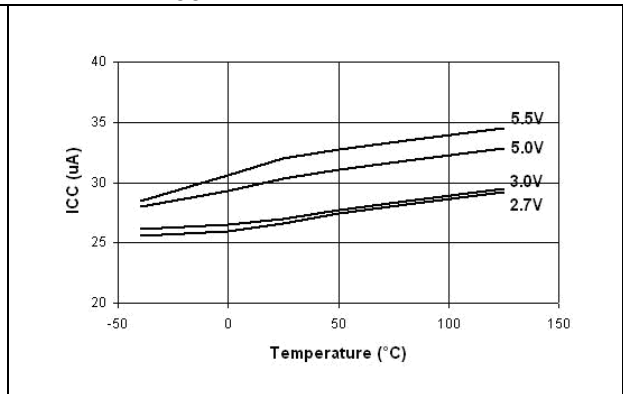

Figure 19. I_{CC} vs V_{IN} (disabled)

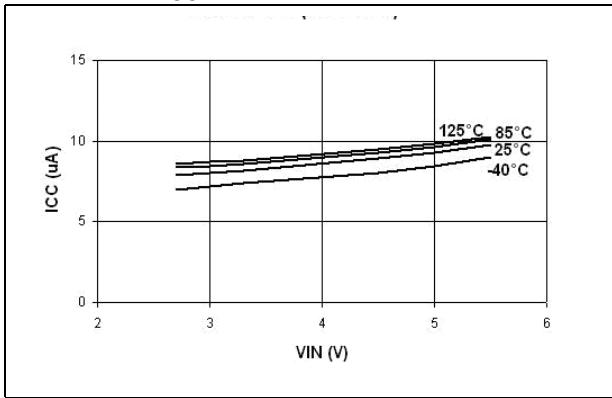

Figure 20. I_{CC} vs temperature (disabled)

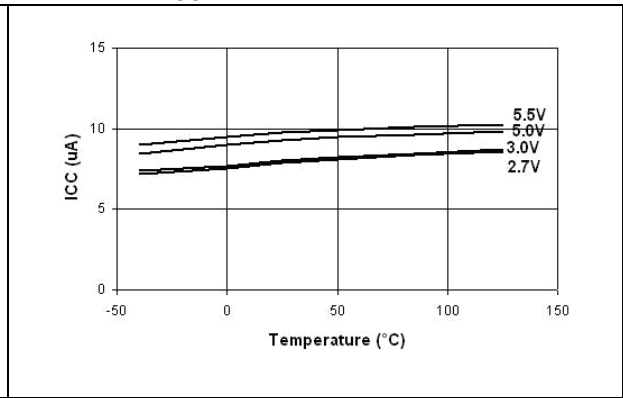

Figure 21. $R_{DS ON}$ vs V_{IN}

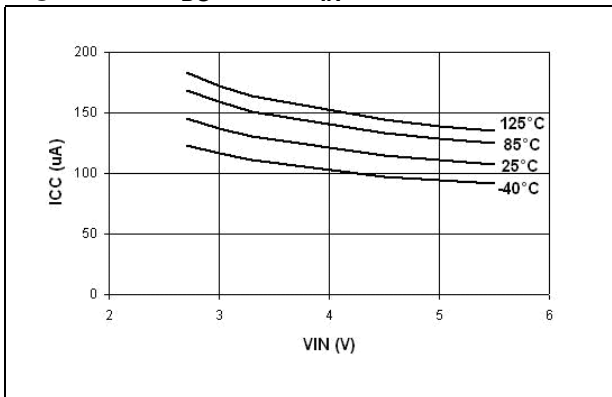

Figure 22. $R_{DS ON}$ vs temperature

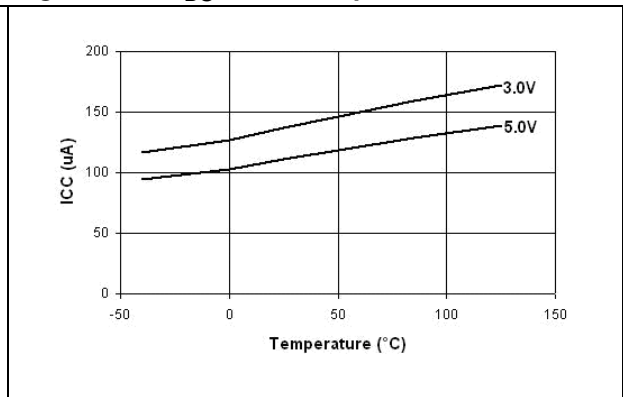

Figure 23. I_{LIMIT} vs temperature

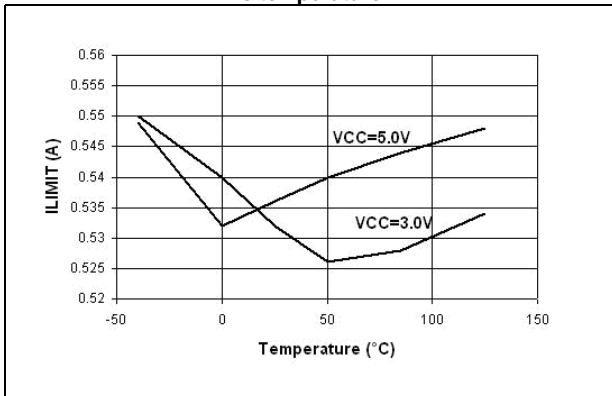

Figure 24. Switch leakage vs temperature

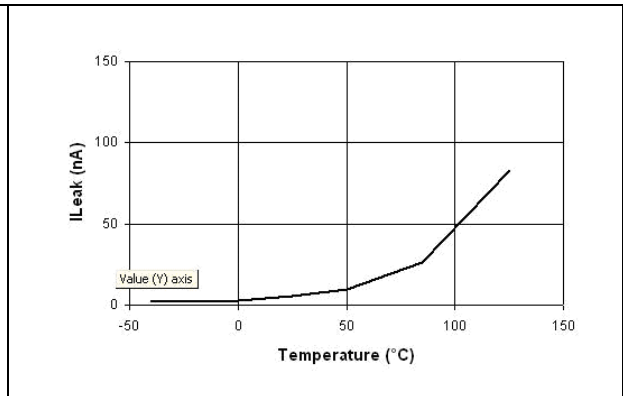

Figure 25. Output rise time vs. V_{IN}

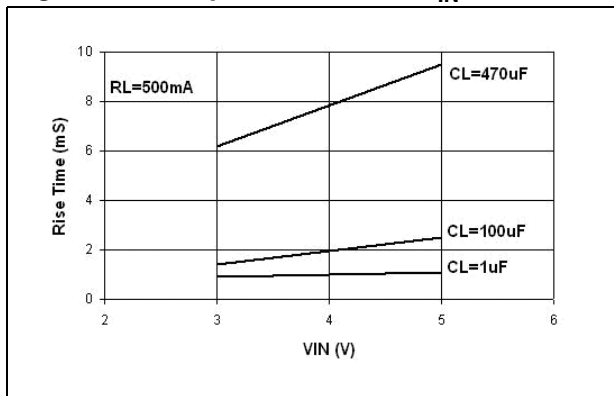

Figure 26. Output fall time vs. V_{IN}

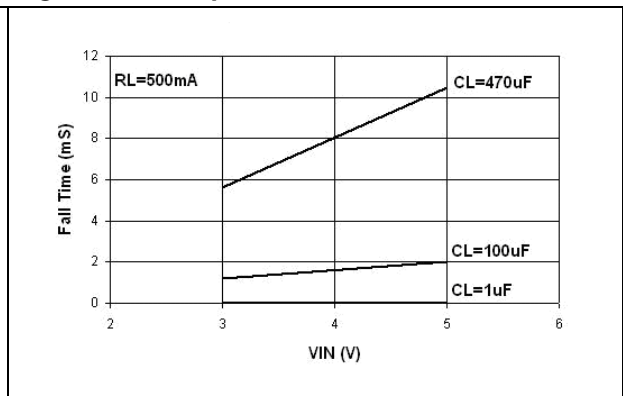
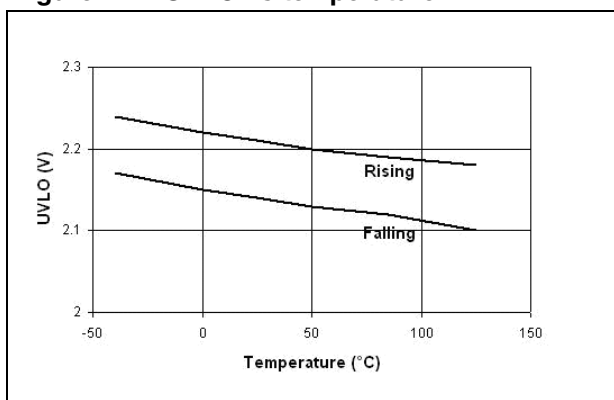

Figure 27. UVLO vs temperature



7.2 STMPS2161, STMPS2171 electrical charts

7.2.1 Turn on/off characteristics at $V_{OUT} = 5.0\text{ V}$

Figure 28. Voltage output turn on delay time

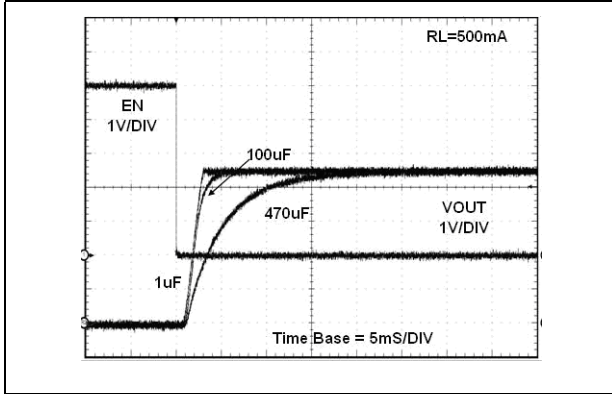

Figure 29. Voltage output turn off delay time

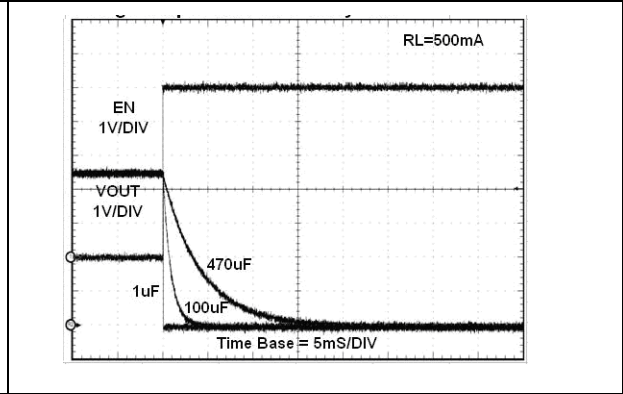

Figure 30. Current output turn on delay time

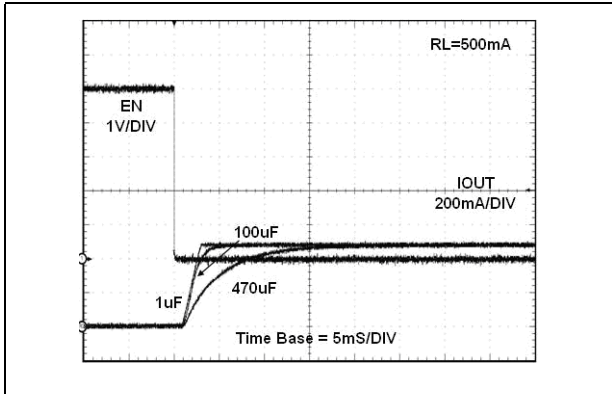
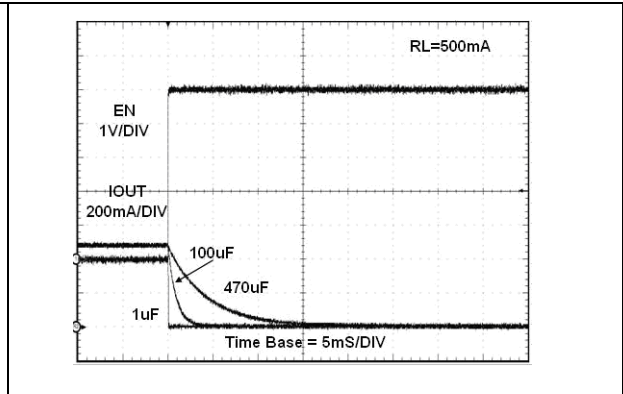

Figure 31. Current output turn off delay time



7.2.2 Turn on/off characteristics at $V_{OUT} = 3.0\text{ V}$

Figure 32. Voltage output turn on delay time

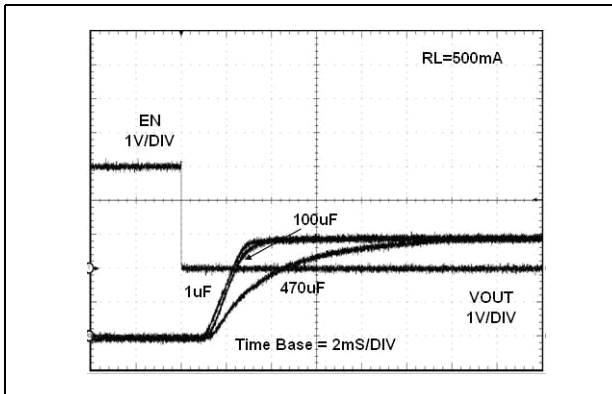

Figure 33. Voltage output turn off delay time

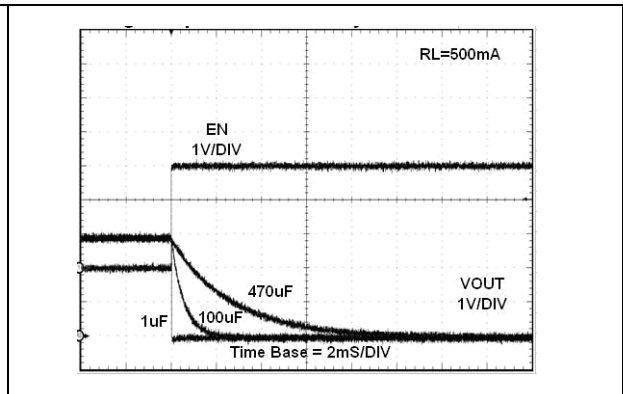

Figure 34. Current output turn on delay time

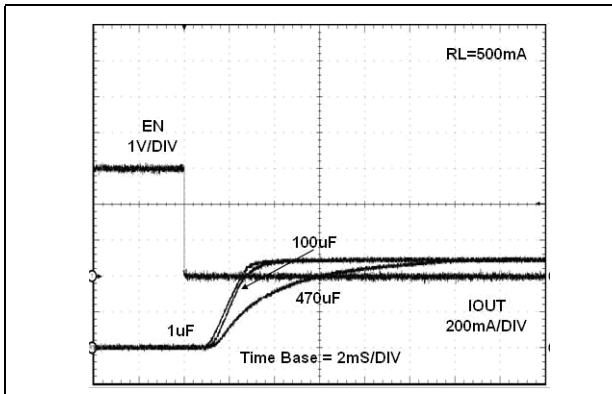
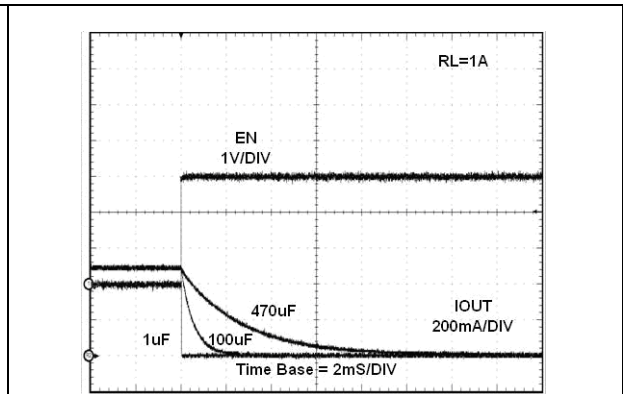

Figure 35. Current output turn off delay time



7.2.3 UVLO

Figure 36. UVLO rising

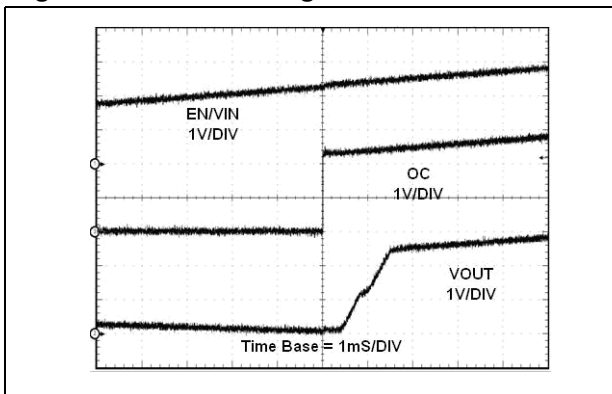
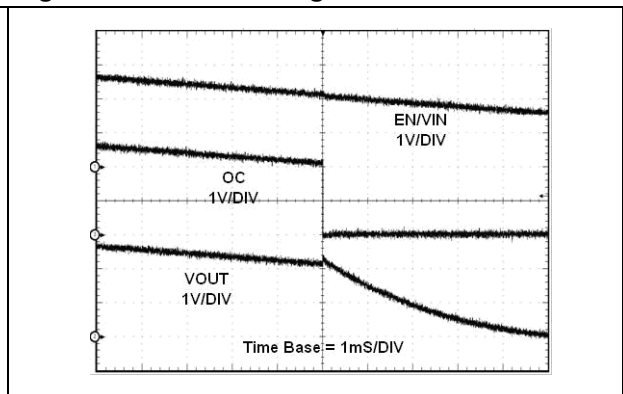

Figure 37. UVLO falling



7.2.4 OC protection characteristics

Figure 38. OC protection at $V_{OUT} = 3.0\text{ V}$

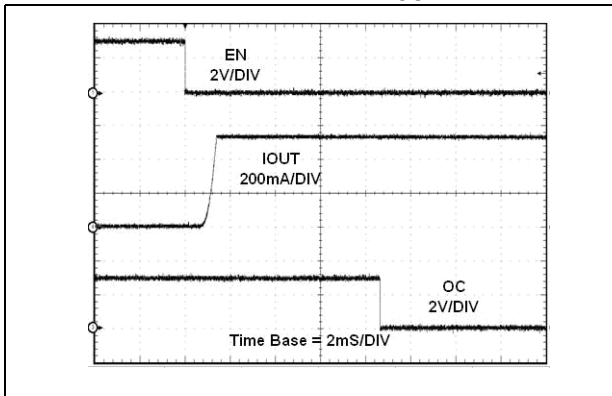

Figure 39. OC protection at $V_{OUT} = 3.0\text{ V}$

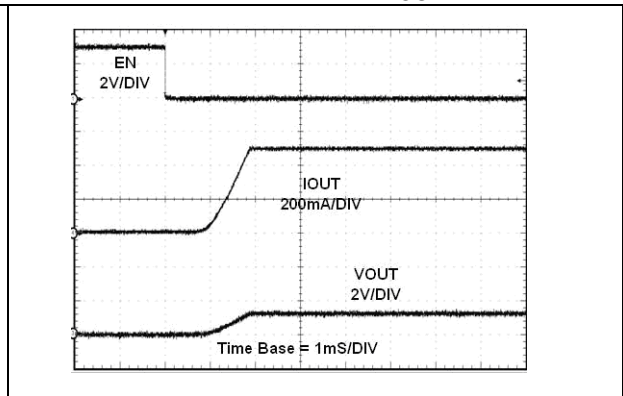

Figure 40. OC protection at $V_{OUT} = 5.0\text{ V}$

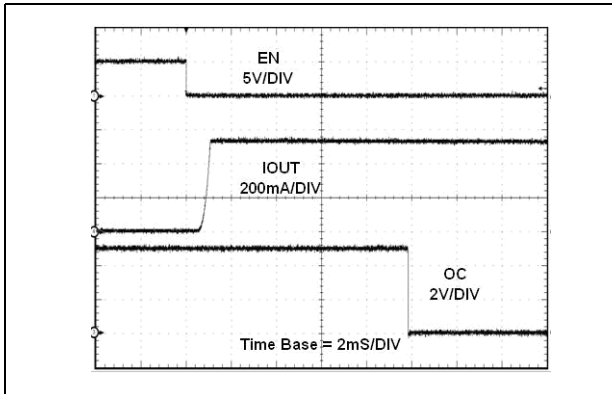
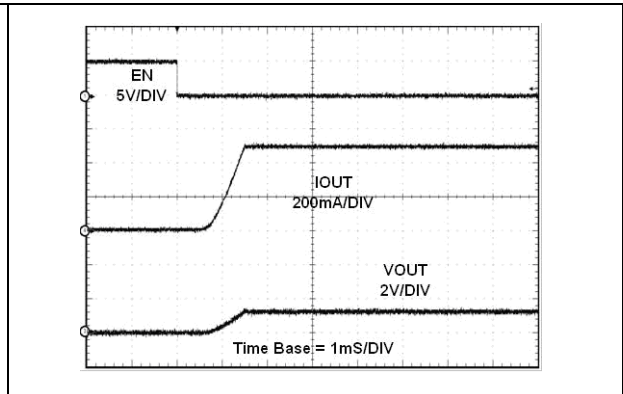

Figure 41. OC protection at $V_{OUT} = 5.0\text{ V}$



7.2.5 Other electrical characteristics

Figure 42. I_{CC} vs V_{IN} (enabled)

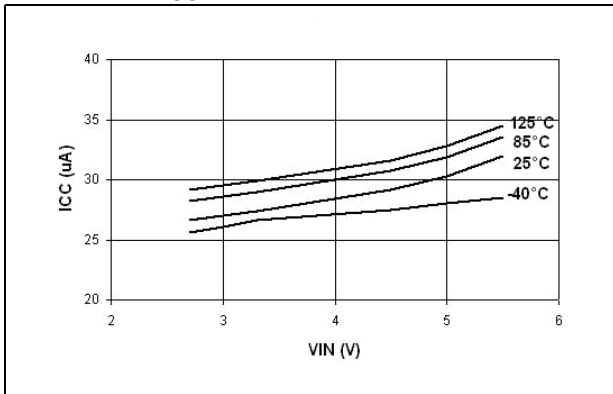

Figure 43. I_{CC} vs temperature (enabled)

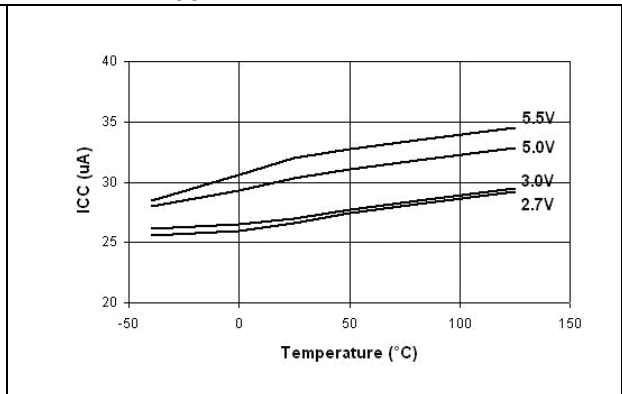

Figure 44. I_{CC} vs V_{IN} (disabled)

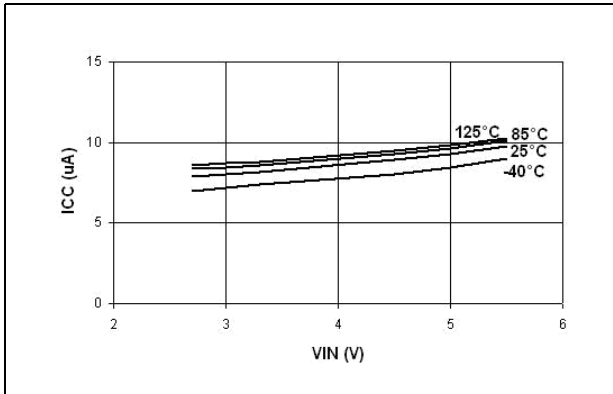

Figure 45. I_{CC} vs temperature (disabled)

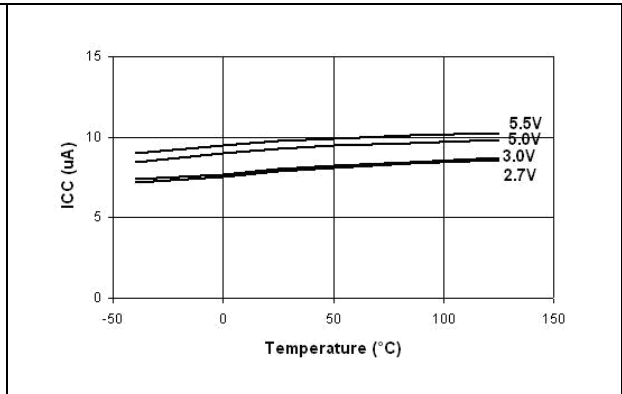

Figure 46. $R_{DS ON}$ vs V_{IN}

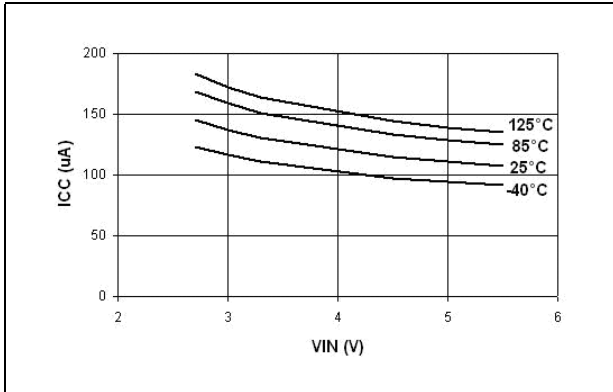

Figure 47. $R_{DS ON}$ vs temperature

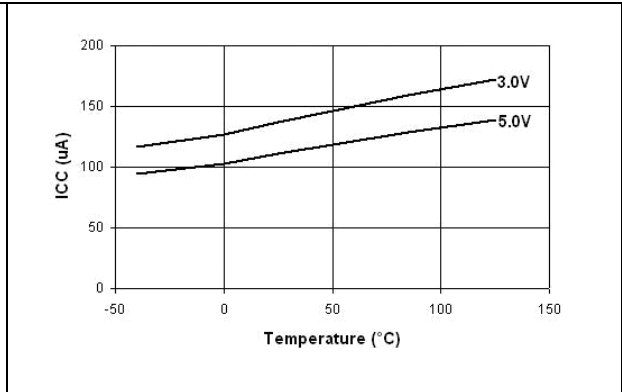

Figure 48. ILIMIT vs temperature

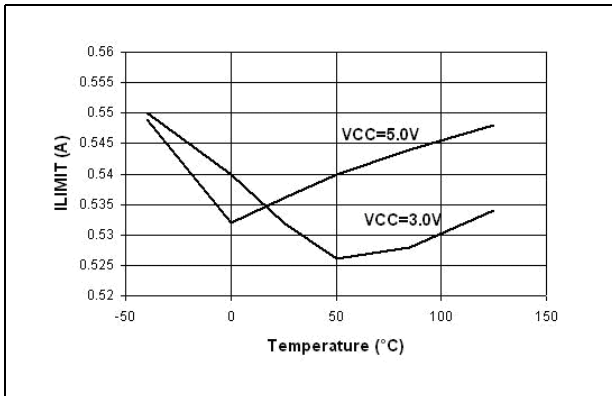

Figure 49. Switch leakage vs temperature

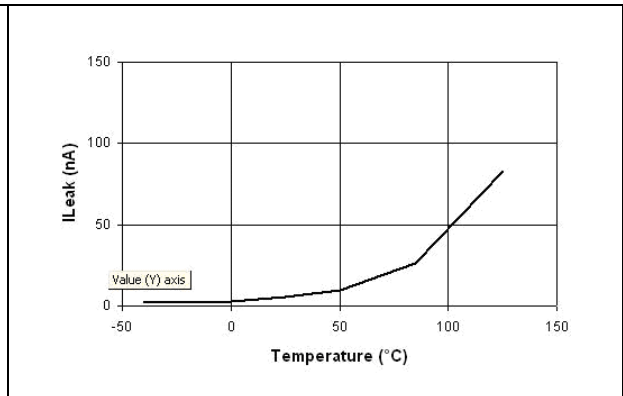

Figure 50. Output rise time vs. VIN

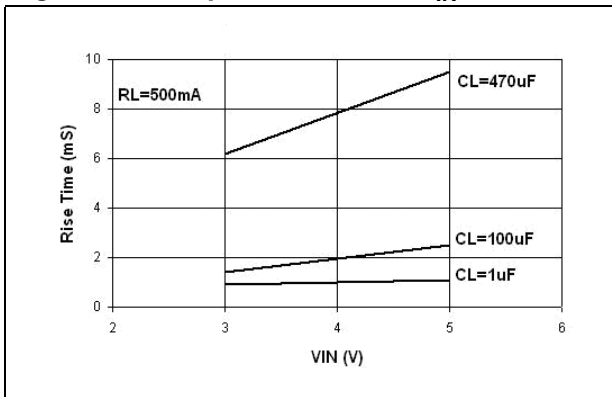

Figure 51. Output fall time vs. VIN

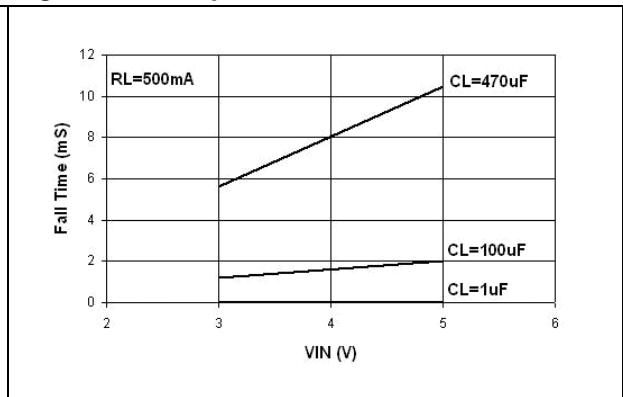
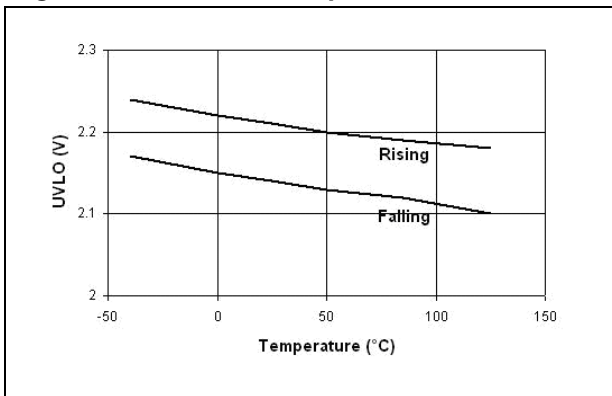

Figure 52. UVLO vs temperature



8 Package mechanical data

In order to meet environmental requirements, ST offers these devices in ECOPACK® packages. These packages have a Lead-free second level interconnect. The category of second level interconnect is marked on the package and on the inner box label, in compliance with JEDEC Standard JESD97. The maximum ratings related to soldering conditions are also marked on the inner box label. ECOPACK is an ST trademark. ECOPACK specifications are available at: www.st.com.

Figure 53. SOT23-5L package outline

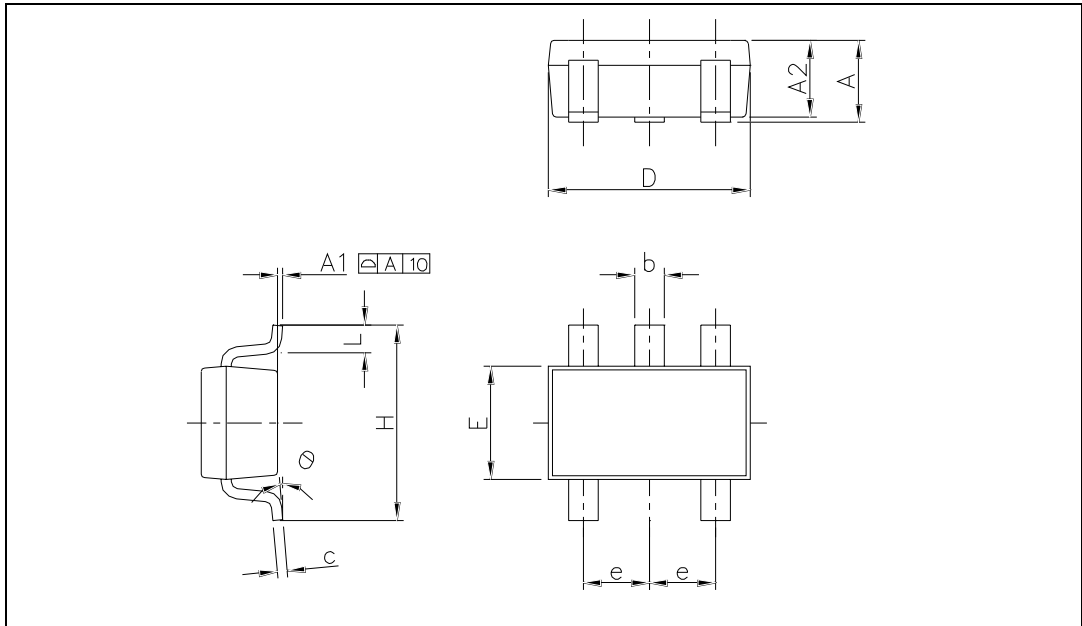

Table 17. SOT23-5L mechanical data

Symbol.	millimeters			inches		
	Min	Typ	Max	Min	Typ	Max
A	0.90		1.45	35.4		57.1
A1	0.00		0.10	0.0		3.9
A2	0.90		1.30	35.4		51.2
b	0.35		0.50	13.7		19.7
C	0.09		0.20	3.5		7.8
D	2.80		3.00	110.2		118.1
E	1.50		1.75	59.0		68.8
e		0.95			37.4	
H	2.60		3.00	102.3		118.1
L	0.10		0.60	3.9		23.6

Figure 54. SOT23-5L footprint recommendation

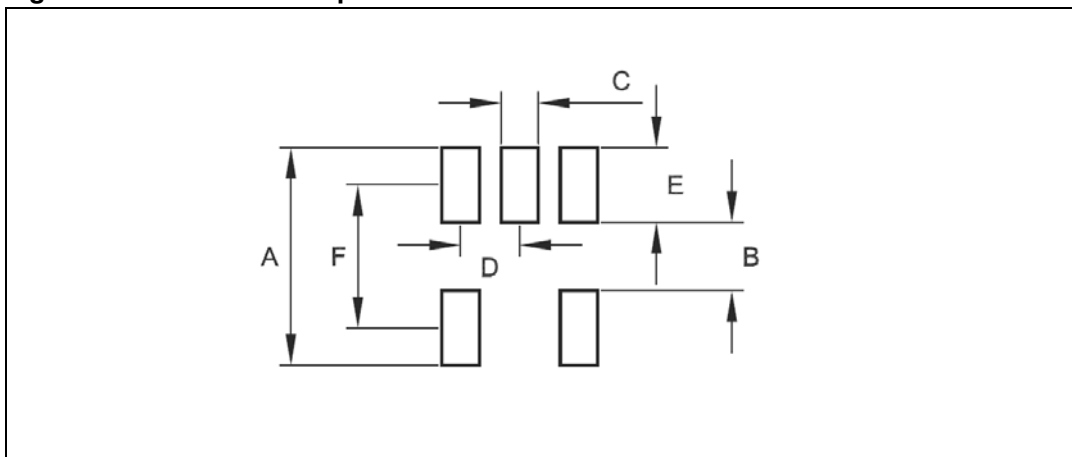
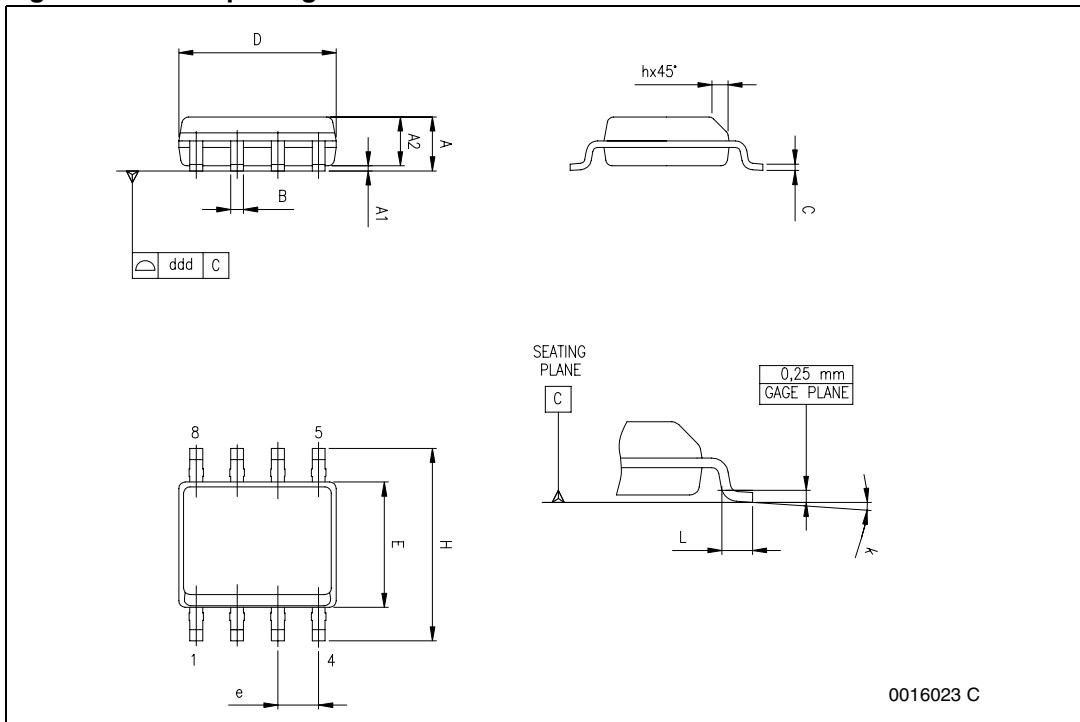

Table 18. SOT23-5L footprint dimensions

Footprint data		
Symbol	millimeters	inches
A	3.50	0.138
B	1.10	0.043
C	0.60	0.024
D	0.95	0.037
E	1.20	0.047
F	2.30	0.090

Figure 55. SO-8 package outline



1. Drawing not to scale

Table 19. SO-8 mechanical data

Symbol	millimeters			inches		
	Min	Typ	Max	Min	Typ	Max
A	1.35		1.75	0.053		0.069
A1	0.10		0.25	0.004		0.010
A2	1.10		1.65	0.043		0.065
B	0.33		0.51	0.013		0.020
C	0.19		0.25	0.007		0.010
D ⁽¹⁾	4.80		5.00	0.189		0.197
E	3.80		4.00	0.15		0.157
e		1.27			0.050	
H	5.80		6.20	0.228		0.244
h	0.25		0.50	0.010		0.020
L	0.40		1.27	0.016		0.050
k	0° (min.), 8° (max.)					
ddd			0.10			0.004

1. Dimension D does not include mold flash, protrusions or gate burrs. Mold flash, protrusions or gate burrs shall not exceed 0.15mm (.006inch) in total (both sides).

Figure 56. MSOP8 package outline

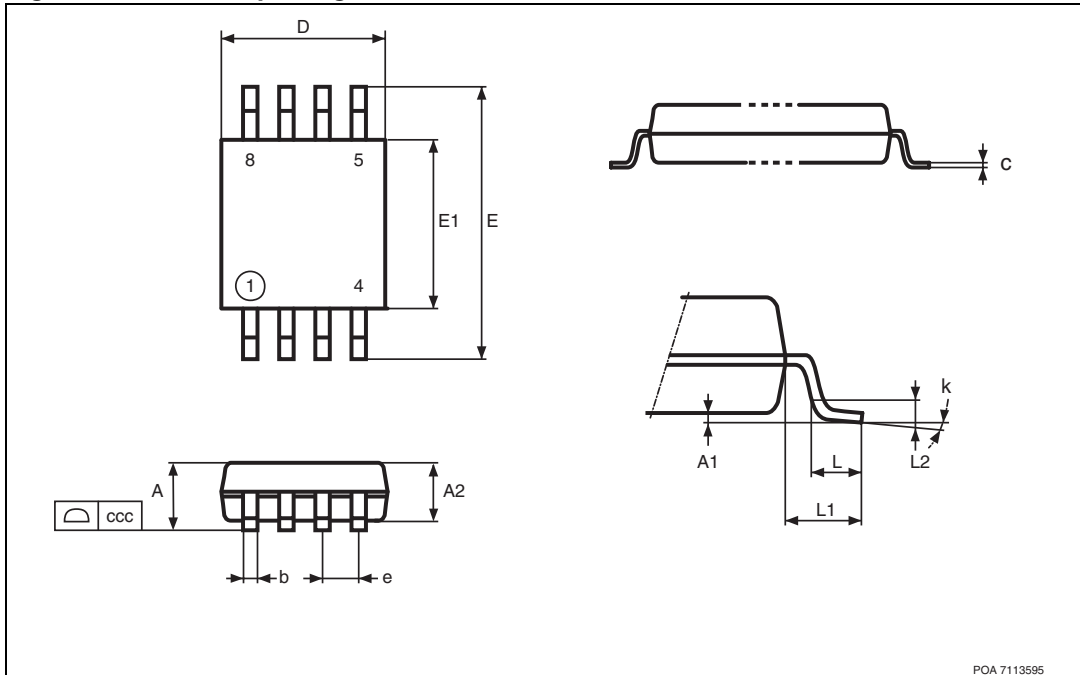

1. Drawing not to scale.

Table 20. MSOP8 package mechanical data

Symbol	millimeters			inches		
	Min	Typ	Max	Min	Typ	Max
A	—	—	1.10	—	—	0.043
A1	0.05	—	0.15	0.002	0.004	0.006
A2	0.75	0.85	0.95	0.031	0.034	0.037
b	0.25	—	0.40	0.010	0.013	0.016
c	0.13	—	0.23	0.005	0.007	0.009
D	2.90	3.00	3.10	0.114	0.118	0.122
E	4.65	4.90	5.15	0.187	0.193	0.199
E1	2.90	3.00	3.10	0.114	0.118	0.122
e	—	0.65	—	—	0.026	—
L	0.40	0.55	0.70	0.016	0.022	0.028
L1	—	0.95	—	—	0.037	—
K	0°	—	6°	0°	—	6°
ccc	—	—	0.10	—	—	0.004

9 Revision history

Table 21. Document revision history

Date	Revision	Changes
01-Aug-2007	1	Initial release.
18-Dec-2007	2	Minor text changes, updated Figure 53 on page 25 , added Section 7: Detail device characteristics on page 15 .
24-Jan-2008	3	Footnote added in Table 1 on page 1 , replaced Figure 56 on page 28 and Table 20 on page 28 , TSSOP8 package name replaced with MSOP8.

Please Read Carefully:

Information in this document is provided solely in connection with ST products. STMicroelectronics NV and its subsidiaries ("ST") reserve the right to make changes, corrections, modifications or improvements, to this document, and the products and services described herein at any time, without notice.

All ST products are sold pursuant to ST's terms and conditions of sale.

Purchasers are solely responsible for the choice, selection and use of the ST products and services described herein, and ST assumes no liability whatsoever relating to the choice, selection or use of the ST products and services described herein.

No license, express or implied, by estoppel or otherwise, to any intellectual property rights is granted under this document. If any part of this document refers to any third party products or services it shall not be deemed a license grant by ST for the use of such third party products or services, or any intellectual property contained therein or considered as a warranty covering the use in any manner whatsoever of such third party products or services or any intellectual property contained therein.

UNLESS OTHERWISE SET FORTH IN ST'S TERMS AND CONDITIONS OF SALE ST DISCLAIMS ANY EXPRESS OR IMPLIED WARRANTY WITH RESPECT TO THE USE AND/OR SALE OF ST PRODUCTS INCLUDING WITHOUT LIMITATION IMPLIED WARRANTIES OF MERCHANTABILITY, FITNESS FOR A PARTICULAR PURPOSE (AND THEIR EQUIVALENTS UNDER THE LAWS OF ANY JURISDICTION), OR INFRINGEMENT OF ANY PATENT, COPYRIGHT OR OTHER INTELLECTUAL PROPERTY RIGHT.

UNLESS EXPRESSLY APPROVED IN WRITING BY AN AUTHORIZED ST REPRESENTATIVE, ST PRODUCTS ARE NOT RECOMMENDED, AUTHORIZED OR WARRANTED FOR USE IN MILITARY, AIR CRAFT, SPACE, LIFE SAVING, OR LIFE SUSTAINING APPLICATIONS, NOR IN PRODUCTS OR SYSTEMS WHERE FAILURE OR MALFUNCTION MAY RESULT IN PERSONAL INJURY, DEATH, OR SEVERE PROPERTY OR ENVIRONMENTAL DAMAGE. ST PRODUCTS WHICH ARE NOT SPECIFIED AS "AUTOMOTIVE GRADE" MAY ONLY BE USED IN AUTOMOTIVE APPLICATIONS AT USER'S OWN RISK.

Resale of ST products with provisions different from the statements and/or technical features set forth in this document shall immediately void any warranty granted by ST for the ST product or service described herein and shall not create or extend in any manner whatsoever, any liability of ST.

ST and the ST logo are trademarks or registered trademarks of ST in various countries.

Information in this document supersedes and replaces all information previously supplied.

The ST logo is a registered trademark of STMicroelectronics. All other names are the property of their respective owners.

© 2008 STMicroelectronics - All rights reserved

STMicroelectronics group of companies

Australia - Belgium - Brazil - Canada - China - Czech Republic - Finland - France - Germany - Hong Kong - India - Israel - Italy - Japan - Malaysia - Malta - Morocco - Singapore - Spain - Sweden - Switzerland - United Kingdom - United States of America

www.st.com